



S SD9366-EHL

Speed Dome Network Camera



1080p 60 fps • 30x Zoom • 150M • Smart IR II • IP66 • IK10 • NEMA 4X • -50°C ~ 55°C • Wiper

The SD9366-EHL is the latest professional speed dome camera with wiper from VIVOTEK, specifically designed to enhance low light surveillance in large coverage areas. Equipped with 150M IR illuminators and a 30x optical zoom lens, the SD9366-EHL provides a superb low light image in the most challenging situations. The camera also adopts VIVOTEK's latest Smart IR II technology, Vari-Angle IR. VIVOTEK's Vari-Angle IR provides smooth vari-angle adjustment of the IR illuminators, allowing broad coverage FOV and highly uniform IR intensity while avoiding hot-spots traditionally associated with IR illumination.

The SD9366-EHL is the PTZ surveillance camera with IR Illumination to utilize H.265 compression technology. When combined with VIVOTEK's Smart Stream II technology users can obtain bandwidth savings of up to 80%* compared to traditional H.264. By combining 1080p full HD resolution with H.265, IR illuminators, Vari-Angle IR, WDR, and 30x optical zoom, the SD9366-EHL is able

to capture fine details at top-notch quality, 24 hours a day, 7 days a week.

VIVOTEK further strengthened the camera performance with an IP66- and NEMA 4X-rated housing to protect the camera against rain, dust, and corrosion. The SD9366-EHL has a wide operating temperature range from -50°C to 55°C, ensuring continuous operation under the most extreme weather conditions and hazardous environments. This makes the SD9366-EHL ideally suited to monitor wide open spaces such as ports, highways, cities, and parking lots where high-level precision is required.

* Depending on scene.

Key Features

- Real-time H.265, H.264 and MJPEG Compression (Triple Codec)
- 60 fps @ 1080p Full HD
- 30x Zoom Lens
- 150M IR with Smart IR II (Vari-Angle IR)
- WDR Pro for Unparalleled Visibility in High Contrast Environments
- Weather-proof IP66, Vandal-proof IK10 and NEMA 4X-rated Housing
- -50°C ~ 55°C Wide Temperature Range for Extreme Weather Conditions (AC 24V/ PoH)
- Smart Stream II to Optimize Bandwidth Efficiency
- EIS
- Easy Cleaning with Built-in Wiper



Without Vari-Angle IR



With Vari-Angle IR

Technical Specifications

Model	SD9366-EHL(with Bracket, IO Cable): 30x, 150M IR SD9366-EHL(without Bracket, IO Cable): 30x, 150M IR
System Information	
CPU	Multimedia SoC (System-on-Chip)
Flash	128 MB
RAM	512 MB
Camera Features	
Image Sensor	1/3" Progressive CMOS
Max. Resolution	1920x1080
Lens Type	30x Optical Zoom, Auto Focus
Focal Length	f = 4.3~129 mm (30x zoom)
Aperture	F1.6 ~ F4.7
Iris type	DC-Iris
Field of View	59° ~ 2° (Horizontal) 45° ~ 2° (Vertical) 71° ~ 3° (Diagonal)
Shutter Time	1/8 sec. to 1/30,000 sec..
WDR Technology	WDR Pro
Day/Night	Yes
Removable IR-cut filter	Yes
Illuminators	Built-in 850nm IR Illuminators up to 150 meters with Smart IR II, IR LED*2
Minimum Illumination	0.42 lux @ F1.6 (Color) 0.01 lux @ F1.6 (B/W) 0 lux with IR illumination on
Pan Speed	0.1° ~ 300° / sec
Pan Range	360° endless
Tilt Speed	0.1° ~ 300° / sec
Tilt Range	220° (-110° ~ +110°)
Preset Locations	256 preset locations 128 presets per tour
Pan/Tilt/Zoom Functionalities	128x digital zoom (4x on IE plug-in, 32x builtin), Auto pan mode, Auto patrol mode
Storage	Seamless Recording to MicroSD/SDHC/SDXC card and recording to network-attached storage (NAS)
Video	
Compression	H265, H264, MJPEG
Maximum Frame Rate	H.265 & H.264: 60 fps @ 1920x1080 MJPEG: 30 fps @ 1920x1080
Maximum Streams	4 video streams (Up to 9 configurable profiles)
S/N Ratio	54 dB
Dynamic Range	110 dB
Video Streaming	Adjustable resolution, quality and bitrate Smart Stream II

Image Settings	Adjustable image size, quality and bit rate; Time stamp, text overlay, flip & mirror; Configurable brightness, contrast, saturation, sharpness, white balance, exposure control, gain, backlight compensation, privacy masks (Up to 24); Scheduled profile settings, defog, 3DNR, EIS, HLC
Audio	
Audio Capability	Two-way audio (Full duplex)
Compression	G.711, G.726
Interface	External microphone input External line output
Network	
Users	Live viewing for up to 10 clients
Security	Access list, digest authentication, HTTPS, IEEE 802.1x, Password protection, signed firmware, Trend Micro IoT Security (brute force attack event, cyberattack event, quarantine event), user access log, user account management
Protocols	802.1X, ARP, Bonjour, CIFS/SMB, DDNS, DHCP, DNS, FTP, HTTP, HTTPS, ICMP, IGMPv3, IPv4, IPv6, NTCIP, NTP, PPPoE, QoS (CoS/DSCP), RTSP/RTP/RTCP, SMTP, SNMP, SSL, TCP/IP, TLS 1.2, UDP, UPnP
Interface	10 Base-T/100 Base-TX Ethernet (RJ-45) *It is highly recommended to use standard CAT5e & CAT6 cables which are compliant with the 3P/ETL standard.
ONVIF	Profile G, S, T supported, specification available at www.onvif.org
Intelligent Video	
Video Motion Detection	Five-window video motion detection
Auto-Tracking	Auto-tracking on moving object
VADP Package	Trend Micro (3-year free trial), Stratocast
Alarm and Event	
Event Trigger	Audio detection, camera tampering detection, cybersecurity events (brute force attack event, cyberattack event, quarantine event), digital input, manual trigger, motion detection, periodical trigger, recording notification, SD card life expectancy, system boot
Event Action	Event notification via audio clip, digital output, email, HTTP, FTP, NAS server, SD card, push notification File upload via email, HTTP, FTP, NAS server, SD card
General	
Connectors	RJ-45 cable connector for 10/100Mbps Network/PoE connection Audio line input Audio line output AC/DC 24V power input Digital input *4 Digital output *2 RS-485 (Pelco D, Baud rate 2400)* 1
LED Indicator	System power and status indicator
Power Input	AC 24V, DC 24V, PoH/PoE (95W) (Simultaneous Power Redundancy Supported)

Technical Specifications

Power Consumption	AC/DC 24V: Max. 63 W (Heater on) Max. 45 W (Heater off) PoH/PoE (95W): Max. 70 W (Heater on) Max. 51 W (Heater off)
Dimensions	237 x 364 mm
Weight	7.1 kg (with bracket) 5.7 kg (without bracket)
Certifications	EMC: CE, LVD, FCC Class A, VCCI; Safety: UL; Environment: IK10, IP66, NEMA 4X
Operating Temperature	Starting Temperature: -40°C ~ 55°C (-40°F ~ 131°F) Working Temperature: -40°C ~ 55°C (-40°F ~ 131°F) (DC 24V) -50°C ~ 55°C (-58°F ~ 131°F) (AC 24V/PoH (95W)) *Wiper is functional at 10°C to 55°C (50°F to 131°F)
Humidity	98% RH (non-condensing)
Warranty	36 months
System Requirements	
Operating System	Microsoft Windows 10/8/7 Mac 10.12 (Chrome only)
Web Browser	Chrome 58.0 or above Internet Explorer 10/11
Other Players	VLC: 1.1.11 or above







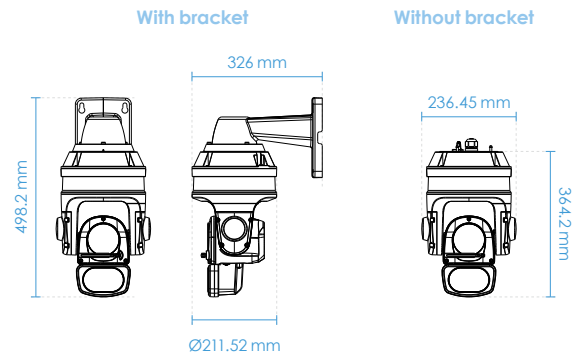









Included Accessories

Packing Contents	Wall mount bracket, I/O cable, screws, waterproof connectors, terminal blocks, quick installation guide, alignment sticker, ground wire, T25 star driver, desiccant bags
------------------	--

Dimensions



Compatible Accessories

Mounting Kits		Others			
					
AM-220 Wall Mount Bracket	AM-529 Mounting Adapter	AE-301 Water Tank, 24VAC/DC, 0°C ~ 60°C	AJ-001 USB Joystick	AJ-002 USB Joystick	AO-007 I/O Combo Cable
Cabinet					
					
AT-CAS-001 Cabinet for Speed Dome	AT-CAB-002 Cabinet for HLG Power Supply	AT-SUN-002 Sunshield	AT-SWH-000 Power Safety Kit		
24VDC					
					
AA-352 Outdoor Power Box, 24VAC/144W, IP67, IK10	HLG-120H-24 Industrial 24VDC/120W Power Supply, IP67				
95W PoH/PoE					
					
AP-GIC-011A-095 1xGE 95W PoH/PoE Injector with Surge Protection 12KV	AP-GIC-015B-095 Outdoor 1xGE 95W PoH/PoE Injector with Surge Protection 12KV, IP67, IK10				